



AC Split Core Current Transducer Type ETS40 Series

The ETS40 series are split-core current transducers. The transducer can be mounted to existing panels, such as control centers or load centers, to measure or monitor wattage. These CTs can be mounted without removing existing cables for easier installation



Electrical Specifications

MODEL	INPUT CURRENT	AVAILABLE OUTPUT
ETS40-200	200 A	POWER SUPPLY@18~30V CURRENT OUTPUTS @4~20mA
ETS40-300	300 A	
ETS40-400	400 A	
ETS40-500	500 A	
ETS40-600	600 A	

Mechanical Dimensions in mm

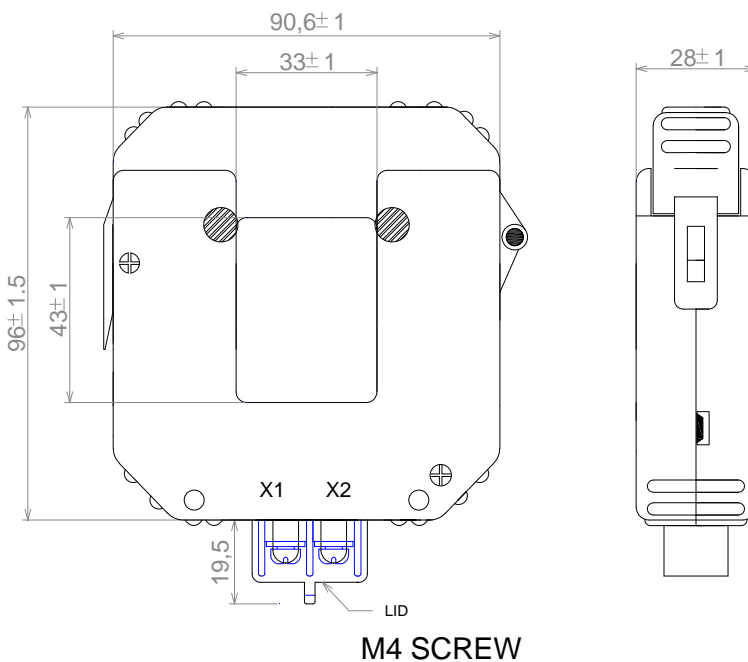

APPLICATIONS

- Phase fired controlled heaters
- Quickly varying motor loads
- Chopped wave form drivers
- Current measurements

FEATURES

- Split Core design
- 4-20 mA DC output; 18-30VDC powered
- 33*43 mm windows size
- 0~600A current customized
- Accuracy 1%
- Frequency range 20 Hz - 5 KHz
- Weight 500g

Advantage

- Easy installation
- Excellent linearity over the whole range
- Compact case
- High isolation between primary and secondary

Connection Diagram

